

PATENT ABSTRACTS OF JAPAN

(11)Publication number : **05-073203**

(43)Date of publication of application : **26.03.1993**

(51)Int.Cl. **G06F 3/03**
G06F 3/033
G06K 9/62

(21)Application number : **03-231241** (71)Applicant : **TOSHIBA CORP**
 (22)Date of filing : **11.09.1991** (72)Inventor : **SAKAMOTO HIROYUKI**

(54) HANDWRITING INPUT DEVICE

(57)Abstract:

PURPOSE: To facilitate the handwriting input with a handwriting input device even if it is operated in the different directions based on plural names.
 CONSTITUTION: A monolithic display input device 10 contains an LCD 11 and a tablet 12 put on each other. An input area is shown on an LCD 11 for input of the information on the characters, etc. In this input area, the information is inputted based on the coordinates inputted through the tablet 12. A display data revolving part 28 revolves the input area at an optional angle to change the direction of the area. Then the information is also inputted through the input area whose direction is changed in accordance with the input coordinates and the revolving angle. Meanwhile a coordinate correction memory 26 stores the coordinate correction data for correction of a coordinate error caused by the different handwriting input directions. Then the inputted coordinates are corrected based on the coordinate correction data accordant with the direction of the input area.

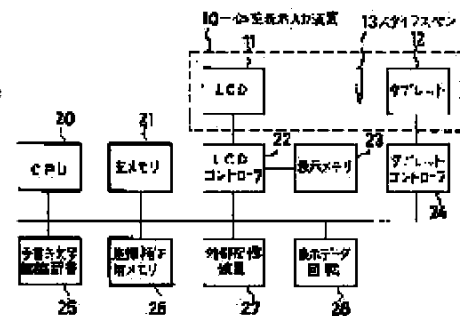

(19)日本国特許庁 (JP)

(12) 公開特許公報 (A)

(11)特許出願公開番号

特開平5-73203

(43)公開日 平成5年(1993)3月26日

(51)Int.Cl. ⁵	識別記号	庁内整理番号	F I	技術表示箇所
G 0 6 F 3/03	3 8 0 B	7927-5B		
		M 7927-5B		
	3/033	3 5 0 D		
G 0 6 K 9/62		G 8219-5L		

審査請求 未請求 請求項の数 2(全 9 頁)

(21)出願番号 特願平3-231241

(22)出願日 平成3年(1991)9月11日

(71)出願人 000003078

株式会社東芝

神奈川県川崎市幸区堀川町72番地

(72)発明者 坂本 広幸

東京都青梅市末広町2丁目9番地 株式会社東芝青梅工場内

(74)代理人 弁理士 鈴江 武彦

(54)【発明の名称】 手書き入力装置

(57)

c

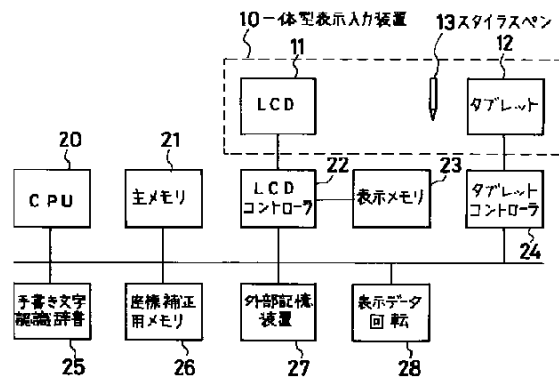

こ

(2)

1

2

2

10

5

c

c

2

20

c

c

c

c

c

30

c

2

c

40

c

2

c

50

c

2

(3)

3

4

こ

こ

こ

こ

c

c

じ

c

10

こ

c

c

5

5

c

20

こ

c

c

じ

じ

30

じ

5

c

5

40

じ

こ

50

5

3

(4)

5

6

5

こ

こ

こ

10

c

こ

c

こ

こ

20

c

5

5

こ

5

こ

c

c

30

c

c

40 c

c

50

4

(5)

7

8

こ

10

5

5

20

c

5

30

5

c

40

c

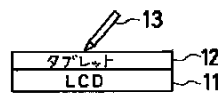
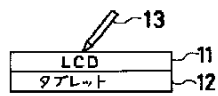
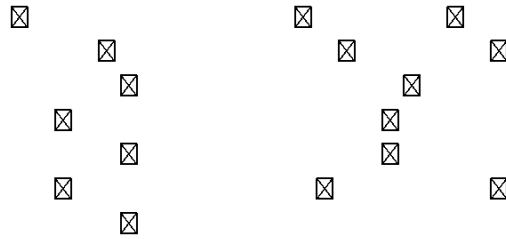

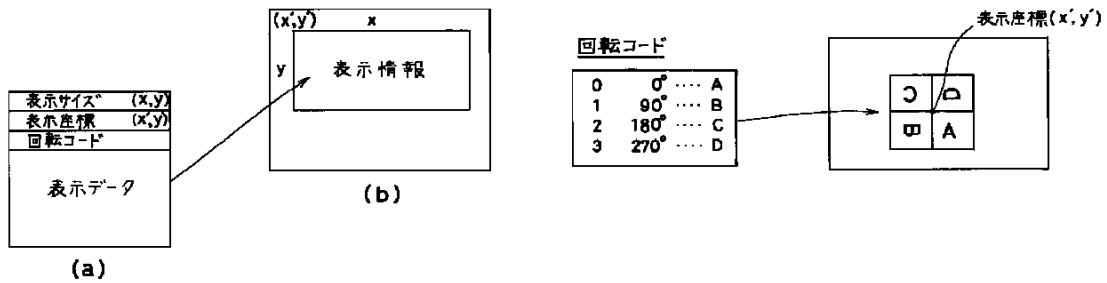
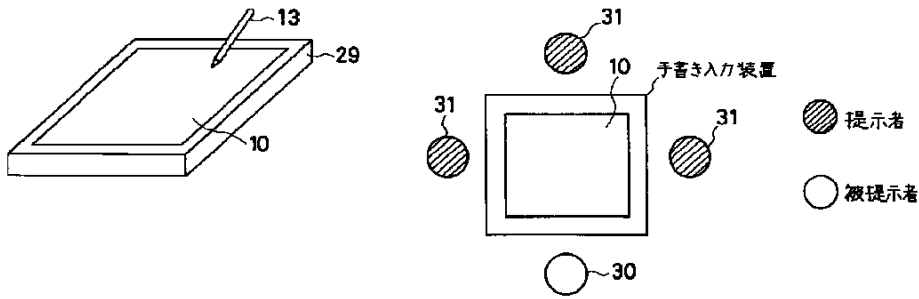
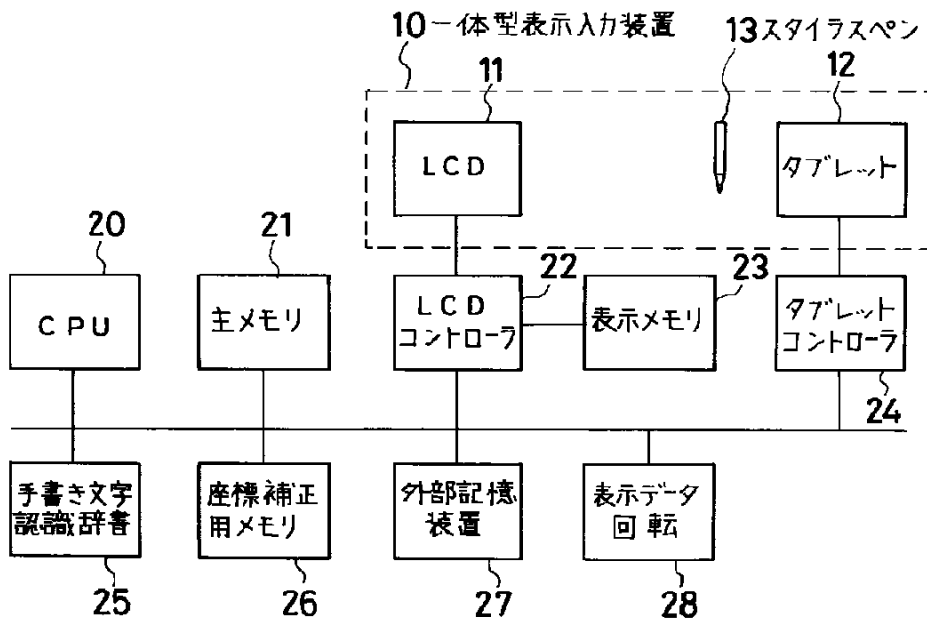

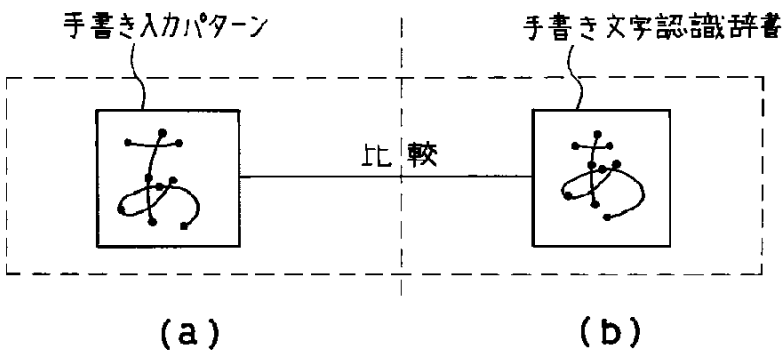
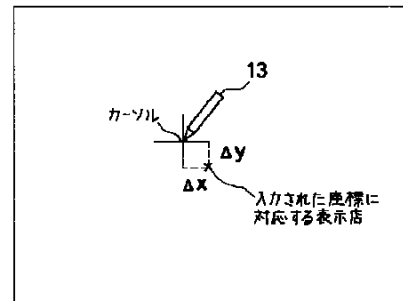
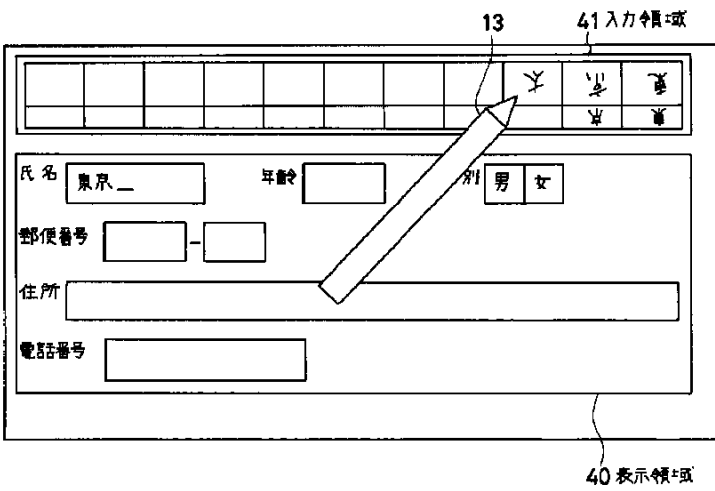
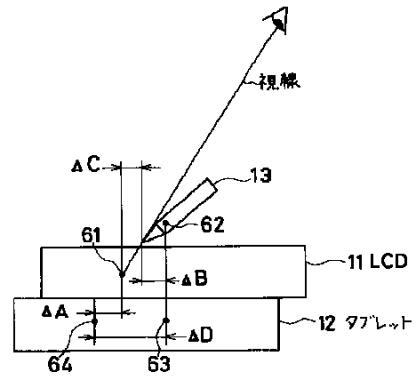
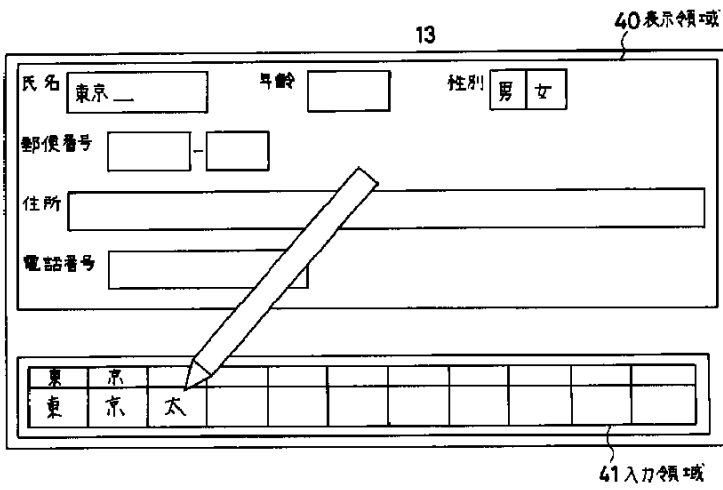

(8)

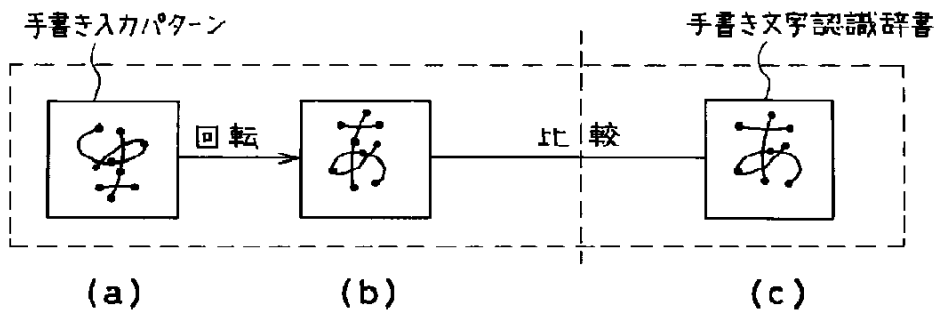

40表示領域

氏名	東京太郎	年齢	25	性別	男	女
郵便番号	[] - []					
住所	[]					
電話番号	[]					

7	8	9	+
4	5	6	x
1	2	3	-
0	.	=	*

43ソフトウェアキーボード

43

+	=	0
-	8	1
x	9	7
÷	6	4

氏名	東京太郎	年齢	25	性別	男	女
郵便番号	[] - []					
住所	[]					
電話番号	[]					

41

(9)

